

SurroundVideo® Omni IP Megapixel Cameras

12MP WDR or 20MP H.264 All-in-One Omni-Directional User-Configurable Multi-Sensor True Day/Night Indoor/Outdoor Dome IP Cameras

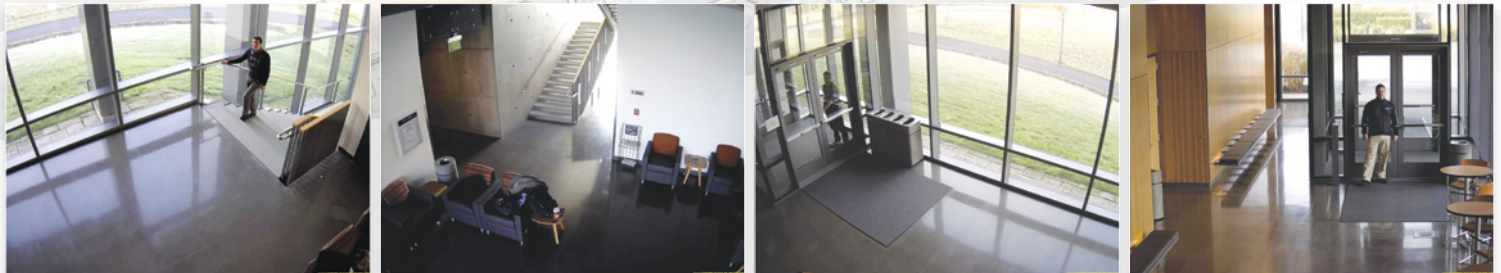

Example images from 12MP SurroundVideo® Omni with WDR and three 3mm and one 12mm lens

Use One Megapixel SurroundVideo® Omni for a Wide Range of Requirements.

Delivering revolutionary flexibility, Arecont Vision SurroundVideo® Omni multi-sensor, multi-megapixel cameras provide ample resolution to zoom-in for details in live and recorded video. With multiple imagers, each with a choice of an IR corrected lens, one SurroundVideo® Omni can replace 4 standard cameras, requiring just a single installation with only one ethernet cable.

A unique track design allows four individual sensor gimbals to be independently placed in nearly any configuration. Popular uses of SurroundVideo® Omni IP66 rated / IK-10 impact-resistant cameras are to

cover the intersection of hallways or to provide a 270° view at the corner of a building.

SurroundVideo® Omni cameras are available in total resolutions of 12 megapixels (MP) or 20 megapixels. Optional lenses can be selected from a choice of 2.8, 4, 6, 8, 12 and 16mm. Wide Dynamic Range (WDR) that delivers up to 100dB at full resolution is available in the 12MP model. H.264 compression reduces bandwidth and storage requirements, while delivering full frame rates and resolution, without sacrificing image quality.



Omni-Directional Track with 4 Customizable Sensors



270° FOV Capable



Wide Dynamic Range on 12MP Models



True Day/Night with IR Cut Filter



Pixel Binning Mode



Dual Encoder H.264/MJPEG



Ultra Low Profile Design



Impact / Weather Resistant IK-10 and IP66 Rated

SurroundVideo® Omni IP Megapixel Cameras



Highlighted Features:

- 12MP WDR and 20MP Configurations
- Up to 4 Individual Camera Gimbals can be Independently Placed in Any Orientation Around a 360° Track with Extra Positions for Looking Straight Down
- Multiple Lens Options in a Single Camera Housing from 2.8mm up to 16mm
- True WDR up to 100dB at Full Resolution: See Clearly in Shaded and Bright Light Conditions Simultaneously
- True Day/Night Functionality with Mechanical IR Cut Filter
- Binning Mode for Strong Low Light Performance
- Forensic Zooming – Zoom Live or After the Event While Recording Full Field-of-View in HD – Replace PTZ Devices
- Fast Frame Rates
- Privacy Mask, Motion Detection, Flexible Cropping, Bit Rate Control and Multi-Streaming
- Dual Encoder H.264/MJPEG
- PoE and Auxiliary Power: 12–48V DC/24V AC
- Ultra Discrete, Low-Profile Housing
- Outdoor Rated IP66 and IK-10 Impact-Resistant Housing
- Complete Mounting Options
- Reduced Overall System Cost
- ONVIF Profile S Conformant
- Made in USA

SurroundVideo® Omni Versatility

The SurroundVideo® Omni can replace multiple single sensor cameras. One example of this is a hallway intersection where the ability to choose different lenses will provide the best possible image quality and pixel density.

Another great example of the versatility of the SurroundVideo® Omni is the corner layout. Configuring the camera's 4 sensors in the corner layout will provide a seamless 270° field of view as well as a view looking directly underneath the camera. No other camera can provide this level of coverage on a building corner.

Indoor Hallway Intersection Layout
(2 Telephoto and 2 Wide Angle Lenses)



Sensor 1

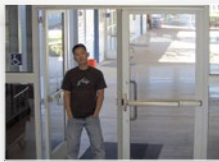

Sensor 2



Sensor 3



Sensor 4

270° Outdoor Corner Layout
(4 90° Lenses)



Sensor 1



Sensor 2



Sensor 3

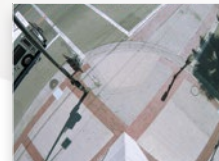

Sensor 4

Reduce the Number of Cameras to Improve Coverage and Simplify Installation

Arecont Vision megapixel technology delivers superior image quality and reduces overall system costs by covering larger areas with fewer cameras.

An area typically requiring multiple pan-tilt-zoom (PTZ) cameras or multiple fixed cameras can be covered with a single SurroundVideo® Omni

multi-sensor camera. SurroundVideo® Omni delivers comprehensive coverage and forensic detail. It is user-configurable to achieve maximum coverage in the desired areas of interest. As a result, SurroundVideo® Omni eliminates the propensity of a PTZ to be facing the wrong way when an incident occurs.

MegaDynamic® Wide Dynamic Range (WDR)

The 12MP SurroundVideo® Omni camera produces clear images in extremely challenging lighting conditions. Arecont Vision's WDR technology delivers a dynamic range of up to 100db at full resolution, without lowering frame rates. WDR maximizes the amount of detail in both bright and dark areas of a scene. The WDR performance of the SurroundVideo® Omni megapixel camera represents an up to 50dB improvement (300x) in dynamic range compared to non-WDR cameras.



Enhanced Low Light Performance

As part of their superior True Day/Night operation, SurroundVideo® Omni cameras include low light enhancing technology with a mechanical IR (infrared) cut filter, pixel binning and adaptive noise-cancellation. Day/Night capability automatically switches from color to black/white operation to increase sensitivity and image clarity at night or in unlit spaces.



H.264 Decompression (example)

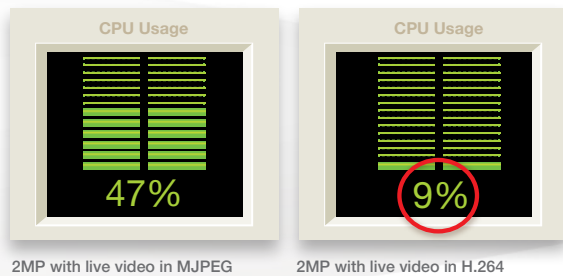

Compliant H.264 Compression by Arecont Vision

SurroundVideo® Omni's compliant implementation of H.264 allows full frame rates and full resolution without sacrificing image quality. With bit rate control, the CPU load of the NVR or VMS servers is decreased at both the client (decompression) side and the server/storage side. This allows lower bandwidth and storage relative to MJPEG. Real Time Streaming Protocol (RTSP) allows for compatibility with Apple QuickTime®, VLC and other media players.

Model Comparison



Model	Sensor	Full Resolution	Max Frame Rate @ Full Resolution	Minimum Illumination	Lens	H.264/MJPEG	True Day/Night	WDR	Binning Mode
AV12176DN-NL	3MP x 4 (12MP)	8192 x 1536 = 12MP	5.2fps	Color (Non-Binning): 0.5 Lux Color (Binning): 0.15 Lux B/W: 0 Lux, IR Sensitive	Sold Separately	•	•	•	•
AV12176DN-28	3MP x 4 (12MP)	8192 x 1536 = 12MP	5.2fps	Color (Non-Binning): 0.5 Lux Color (Binning): 0.15 Lux B/W: 0 Lux, IR Sensitive	M12, 2.8mm, 1/2.5", F1.8, Fixed Iris, H-FOV = 89°	•	•	•	•
AV12176DN-08	3MP x 4 (12MP)	8192 x 1536 = 12MP	5.2fps	Color (Non-Binning): 0.5 Lux Color (Binning): 0.15 Lux B/W: 0 Lux, IR Sensitive	M12, 8mm, 1/2.5", F1.6, Fixed Iris, H-FOV = 33°	•	•	•	•
AV20175DN-NL	5MP x 4 (20MP)	10240 x 1920 = 20MP	3.5fps	Color (Non-Binning): 0.3 Lux Color (Binning): 0.15 Lux B/W: 0 Lux, IR Sensitive	Sold Separately	•	•	•	•
AV20175DN-28	5MP x 4 (20MP)	10240 x 1920 = 20MP	3.5fps	Color (Non-Binning): 0.3 Lux Color (Binning): 0.15 Lux B/W: 0 Lux, IR Sensitive	M12, 2.8mm, 1/2.5", F1.8, Fixed Iris, H-FOV = 113°	•	•	•	•
AV20175DN-08	5MP x 4 (20MP)	10240 x 1920 = 20MP	3.5fps	Color (Non-Binning): 0.3 Lux Color (Binning): 0.15 Lux B/W: 0 Lux, IR Sensitive	M12, 8mm, 1/2.5", F1.6, Fixed Iris, H-FOV = 40°	•	•	•	•

Options

-NL	No Lenses (User Configurable and Ordered Separately)
-28	Configured with 2.8mm Lenses, typical for many 270° Corner Mount configurations
-08	Configured with 8mm Lenses, typical for many hallway intersections



SurroundVideo® Omni IP Megapixel Cameras

Accessory Configurations

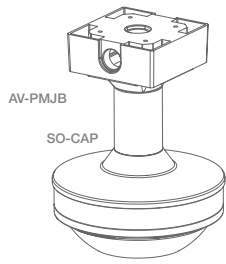

Ceiling Mount

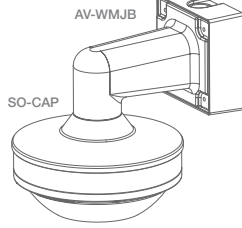

Wall Mount

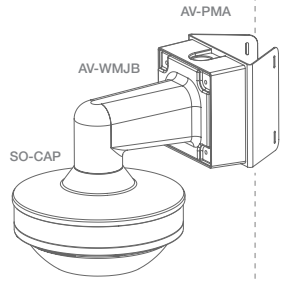

Pole Mount

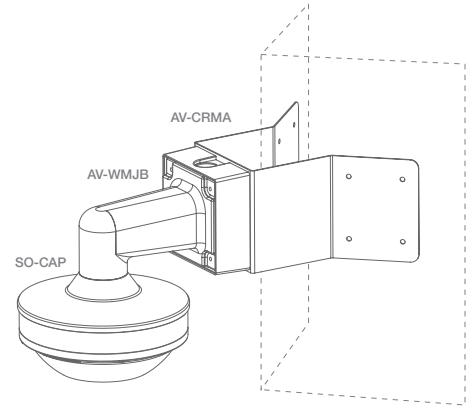

Corner Mount

Accessories

SO-CAP

Cap for SurroundVideo® Omni



AV-WMJB

Wall Mount Adapter with Junction Box



AV-PMJB

Pendant Mount Adapter with Junction Box



AV-PMA

Pole Mount Adapter



AV-CRMA

Corner Mount Adapter



SV-EBA

Electrical Box Adapter



Surface Mount (Standard)



Lens Options

Focal Length		2.8mm	4mm	6mm	8mm	12mm	16mm
F Stop		F1.8	F1.6	F1.6	F1.6	F1.6	F1.6
Horizontal FOV	3MP WDR	89	63	43	33	22	16
	5MP	113	80	55	40	28	20
Option		Standard (-28 Models)	Ordered Separately	Ordered Separately	Standard (-08 Models)	Ordered Separately	Ordered Separately
Part Number		MPM2.8	MPM4.0	MPM6.0	MPM8.0	MPM12.0	MPM16.0

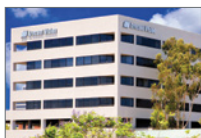

Global Sales and Support

Arecont Vision is the leading manufacturer of high-performance megapixel IP cameras and associated software.

Americas

Los Angeles, CA, USA

Arecont Vision, LLC. Headquarters
425 E. Colorado St., 7th Floor
Glendale, CA 91205, USA

Phone: +1.818.937.0700
Toll Free: 877.CAMERA.8
Fax: +1.818.937.0464

Sales

Phone: +1.818.937.0700 x 3
Email: avsales@arecontvision.com

Support

Phone: +1.818.937.0700 x 1
Email: support@arecontvision.com

Latin America

Email: latam.sales@arecontvision.com

EMEA

Düsseldorf, Germany

Phone: +49.69.6953.4600
Email: europe.sales@arecontvision.com

Moscow, Russia

CJSC Arecont Vision
Phone: +7.495.649.0577
Fax: +7.495.221.5227
Email: info@arecontvision.ru

Middle East

Email: mena.sales@arecontvision.com

Africa

Email: africa.sales@arecontvision.com

APAC

China

Phone: +86.180.0179.1799
Alt. Phone: +1.818.937.0700 x 3
Fax: +1.818.649.3404
Email: apac.sales@arecontvision.com